

BEAM ALIGNMENT UNIT

BAU-4

For:
 SL-QDM (Transmitter/Receiver)
 SL-QDP, SL-QFR, SL-QNR, SL-QN (Receiver only)

Adjust optical axis automatically.

1 BEFORE YOUR OPERATION

- Read this instruction manual carefully prior to installation.
- After reading, store this manual carefully in an easily accessible place for reference.
- This manual uses the following warning indications for correct use of the product, harm to you or other people and damage to your assets, which are described below. Be sure to understand the description before reading the rest of this manual.

	Warning	Failure to follow the instructions provided with this indication and improper handling may cause death or serious injury.
	Caution	Failure to follow the instructions provided with this indication and improper handling may cause injury and/or property damage.

This symbol indicates prohibition. This symbol requires an action or gives an instruction.

	Warning	Do not mix batteries that have different levels of power remaining (i.e., new and used batteries or batteries of different manufactures). Not observing the above may result in an explosion, leakage of electrolyte, emission of toxic gases or other outcomes that may be harmful to people and property.
		Never attempt to disassemble or repair the product. It may cause fire or damage to the devices.
	Caution	Do not apply excessive force with the pin inserted into the monitor jack. It may damage the device.
		Do not touch the gear during its movement. Doing so may result in injury.
		Remove all batteries before replacing them with new ones. Not doing so may shorten the battery life.
		Clean and check the product periodically for safe use. If any problem is found, do not attempt to use the product as it is and have the product repaired by a professional engineer or electrician.
		Do not pour water over the product with a bucket, hose, etc. The water may enter, which may cause damage to the devices.
		Dispose of the product in accordance with the relevant rules and regulations of the country or area where the product is used.

2 PARTS IDENTIFICATION

< Controller >

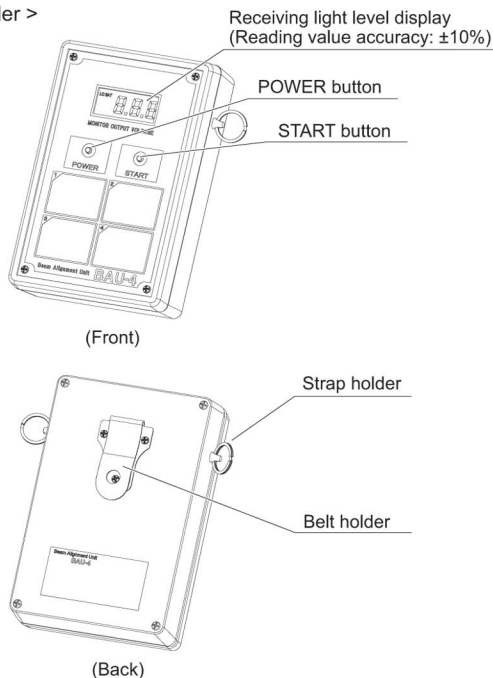

< Motor Head >

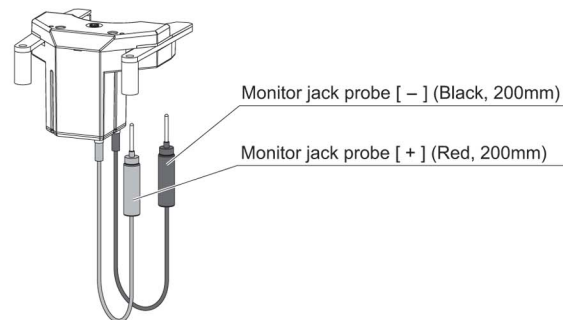

ACCESSORIES >>

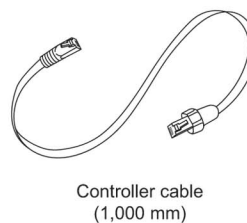

3 SETTING

- 1 Remove the screws (x4) at the back of the controller and set the batteries inside the case.

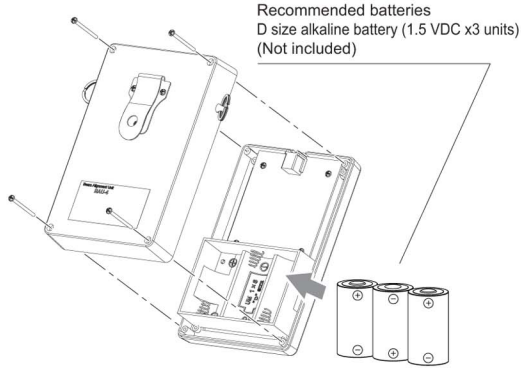

Note >>

When the battery voltage becomes low battery, the display shows "LO BAT", notifying the time for battery replacement.

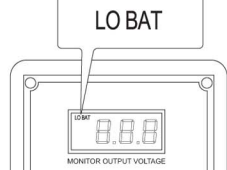

- 2 Connect the controller and motor head with the controller cable.

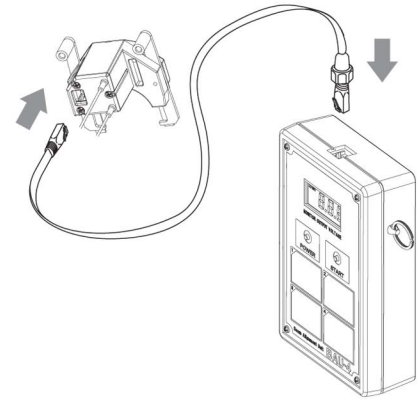

4 HOW TO USE

4-1 OPTICAL ALIGNMENT OF THE UPPER/LOWER LENS UNIT

- 1 Mount the beam blocking plate to the low lens unit.

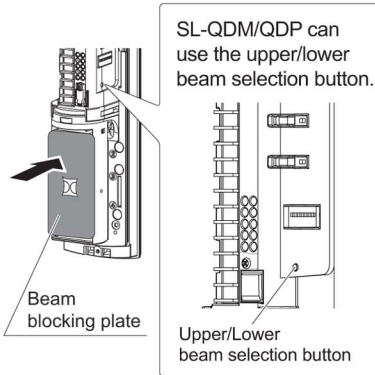

- 2 Visually perform a rough alignment.

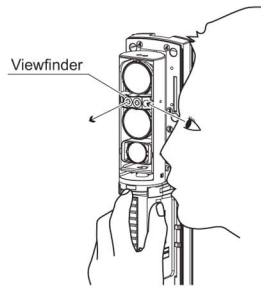

- 3 Mount the motor head to the detector.

Pinch the handle to open the hook at the tip of the motor head. Insert the hook into the groove of the detector, and then release the handle.

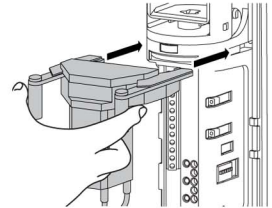

Note >>

To reliably attach the motor head, push the handle firmly as shown.

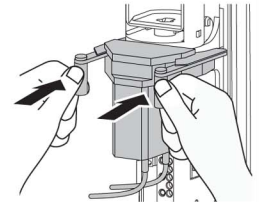

Note >>

Check that edges of the hook and gear cover are aligned as shown.

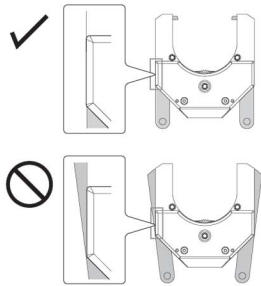

- 4 Connect the red cable to the positive pole (+) and black cable to the negative pole (-).

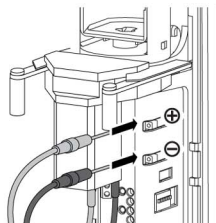

- 5 Press the POWER button.

The receiving light level appears on the digital display. If the receiving light level is not displayed, refer to "Note" on the next page.

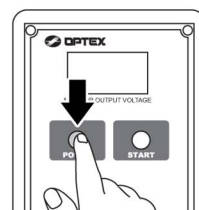

example



- 6 Press the START button.

Auto alignment starts in the order of horizontal and vertical directions. During the back and forth motion, the BAU-4 finally stops at the position of peak value.

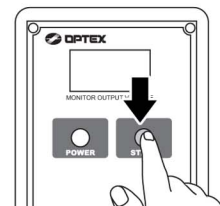

<< During alignment >>

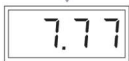

<< Complete (peak value) >>
example



(Optical alignment accuracy: ±10%)

- 7 Next, perform optical alignment to the lower lens unit. Mount the beam blocking plate to the upper lens unit and perform procedure 2 to 6 as well.

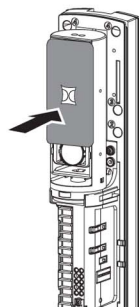

Mount the motor head upside down.

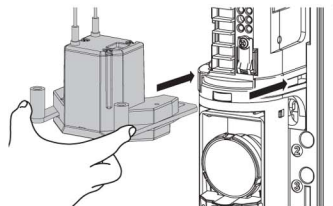

- 8 When turning OFF the power, refer to the following.

- Manual power OFF: Holding the POWER button for 5 seconds

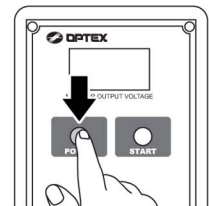

- Auto power OFF: No operation for approximately 3 minutes

Note >>

When you press the POWER button and the display shows "0.00" blinking, it indicates that alignment is not available. In such case, press the POWER button again to reset the blinking of "0.00", make an visual alignment until the receiving beam level display shows up. And then press the START button to perform an auto alignment.

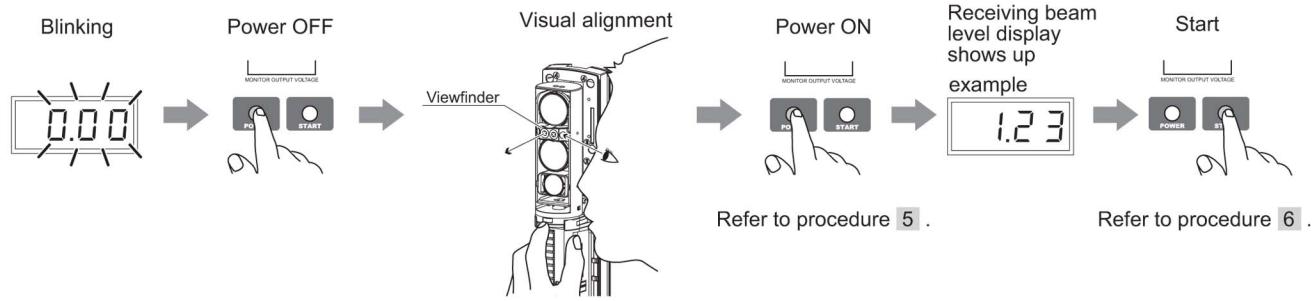

4-2 HOW TO REMOVE THE OBJECT CAUGHT IN THE MOTOR GEAR

1 Remove the controller cable.

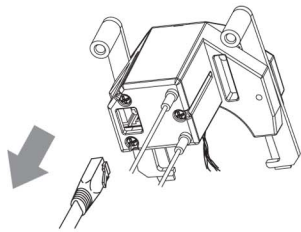

2 Remove the gear cover.

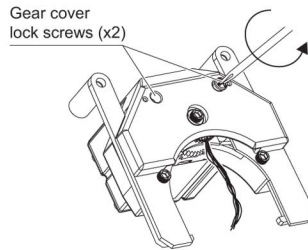

3 Remove the object caught in the motor gear. After removing the object, put the gear cover with screws (x2) back to the motor gear before use.

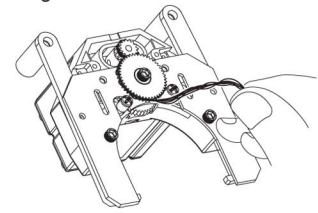

5 SPECIFICATIONS

Recommended battery	D size alkaline battery (1.5 VDC) x3 units
Operating voltage range	4.5 VDC ±10%
Current consumption	Approx. 600 mA max.
Probe input voltage range	0 to 9.99 V
Angle of alignment resolution	1/20° min.
Reading value accuracy of the monitor jack output display	±10%
Optical alignment accuracy	±10%
Cable length	Controller cable: 1000 mm Monitor jack probe: 200 mm
Weight	Controller: 350 g, Motor head: 240 g, In packing: 1350 g
Color	Controller unit: Charcoal gray, Motor head: Fluorescent orange
Package dimensions	H x W x D mm (inch): 305 (12) x 165 (6.5) x 105 (4.1)
Noise characteristics	70dB max.
Operating temperature	0 to 40°C (32 to 104°F)
Operating humidity	95% max. (no condensation)
Accessories	Instruction manual (English), Controller cable (x1), Neck strap (x1)

* Specifications and design are subject to change without prior notice.

6 DIMENSIONS

< Motor Head >

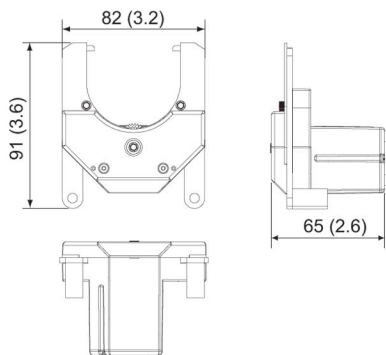

< Controller >

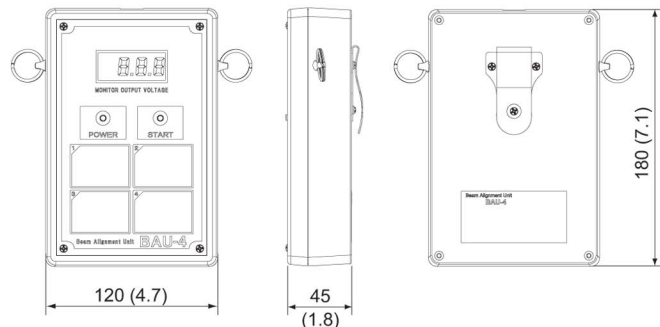

Unit: mm (inch)



Report No. QDC12010A

DECLARATION OF CONFORMITY



Manufacturer : OPTEX CO., LTD.
5-8-12 Ogoto, Otsu, Shiga, 520-0101 JAPAN

European Subsidiary : OPTEX (EUROPE) LTD.
Platinum House 32B Clivemont Road Maidenhead Berkshire, SL6 7BZ U.K.
Atsushi Yasuoka

Product Description : **Beam Alignment Unit**

Model(s) : **BAU-4**

We, OPTEX CO., LTD. herein declare that the above model(s) complies with the following Directive(s) fulfilling the criteria of applicable standard(s) mentioned below.

Directive(s) : Machinery Directive 2006/42/EC ANNEX I

Applied Standard(s) : EN ISO12100:2010

Director SHINJI TAKEMURA
OPTEX CO., LTD.
Total Quality Management Div.
Issued : February 9, 2012

<Original>



OPTEX CO., LTD. (JAPAN)
(ISO 9001 Certified)
(ISO 14001 Certified)
5-8-12 Ogoto Otsu
Shiga 520-0101
JAPAN
TEL:+81-77-579-8670
FAX:+81-77-579-8190
URL:<http://www.optex.co.jp/e/>

OPTEX INCORPORATED (USA)
TEL:+1-909-993-5770
Tech:(800)966-7839
URL:<http://www.optexamerica.com/>

OPTEX (EUROPE) LTD. (UK)
TEL:+44-1628-631000
URL:<http://www.optex-europe.com/>

OPTEX SECURITY SAS (FRANCE)
TEL:+33-437-55-50-50
URL:<http://www.optex-security.com/>

OPTEX SECURITY Sp.z o.o. (POLAND)
TEL:+48-22-598-06-55
URL:<http://www.optex.com.pl/>

OPTEX KOREA CO., LTD. (KOREA)
TEL:+82-2-719-5971
URL:<http://www.optexkorea.com/>

**OPTEX (DONGGUAN) CO., LTD.
SHANGHAI OFFICE (CHINA)**
TEL:+86-21-34600673
URL:<http://www.optexchina.com/>