



**NAPCO**

333 Bayview Avenue  
Amityville, New York 11701  
For Sales and Repairs, (800) 645-9445  
For Technical Service, (800) 645-9440

Publicly traded on NASDAQ Symbol: NSSC

© NAPCO 2010

# GEMC-EZM8

## ZONE EXPANSION MODULE for the GEMINI C-Series Control Panels Installation Instructions

WI1683 08/10

**UL LISTED: BURGLARY AND FIRE WARNING SYSTEM CONTROL UNIT ACCESSORY**

### DESCRIPTION

The capacity of the GEMC-Series control panels may be expanded through the use of a **GEMC-EZM8** Zone Expansion Module. Each GEMC-EZM8 module provides up to 8 additional zones, and may be configured to provide for either 4 zones or 8 zones. Using either configuration, several GEMC-EZM8 modules may be combined as necessary to supply the required number of zones to the GEMC-Series control panel. Refer to the GEMC-Series control panel installation instructions (WI1653) for wiring requirements.

if one or more zones are not used. **NOTE:** The addition of Zone Expansion Modules will reduce the amount of current available by 60mA at the control panel's Auxiliary Power Output terminals.

### WIRING

Wire the expansion zones to the module and the module to the control panel in accordance with the wiring diagrams shown using 12-22AWG wire (see WI1653 for maximum wire length depending on wire gauge and current load of home run). Install end-of-line resistors on all zones, even

### SPECIFICATIONS

#### Electrical Ratings

**Input Power:** 12.5 - 7.5VDC, 60mA.

**Zone Loop current:** 4.7mA nominal, 5.5mA when shorted.

**Maximum Zone Loop Resistance:** 300 ohms.

**2.2K End of line resistor** (UL Listed part number EOL2.2K required in Fire applications).

#### Output Power:

**PGM Output (Active low):** 5mA, 12V. Connect only to power-limited circuits less than 14VDC. Use only in Burglary applications.

**Ground Faults Detected:** 1.25KΩ to ground or less.

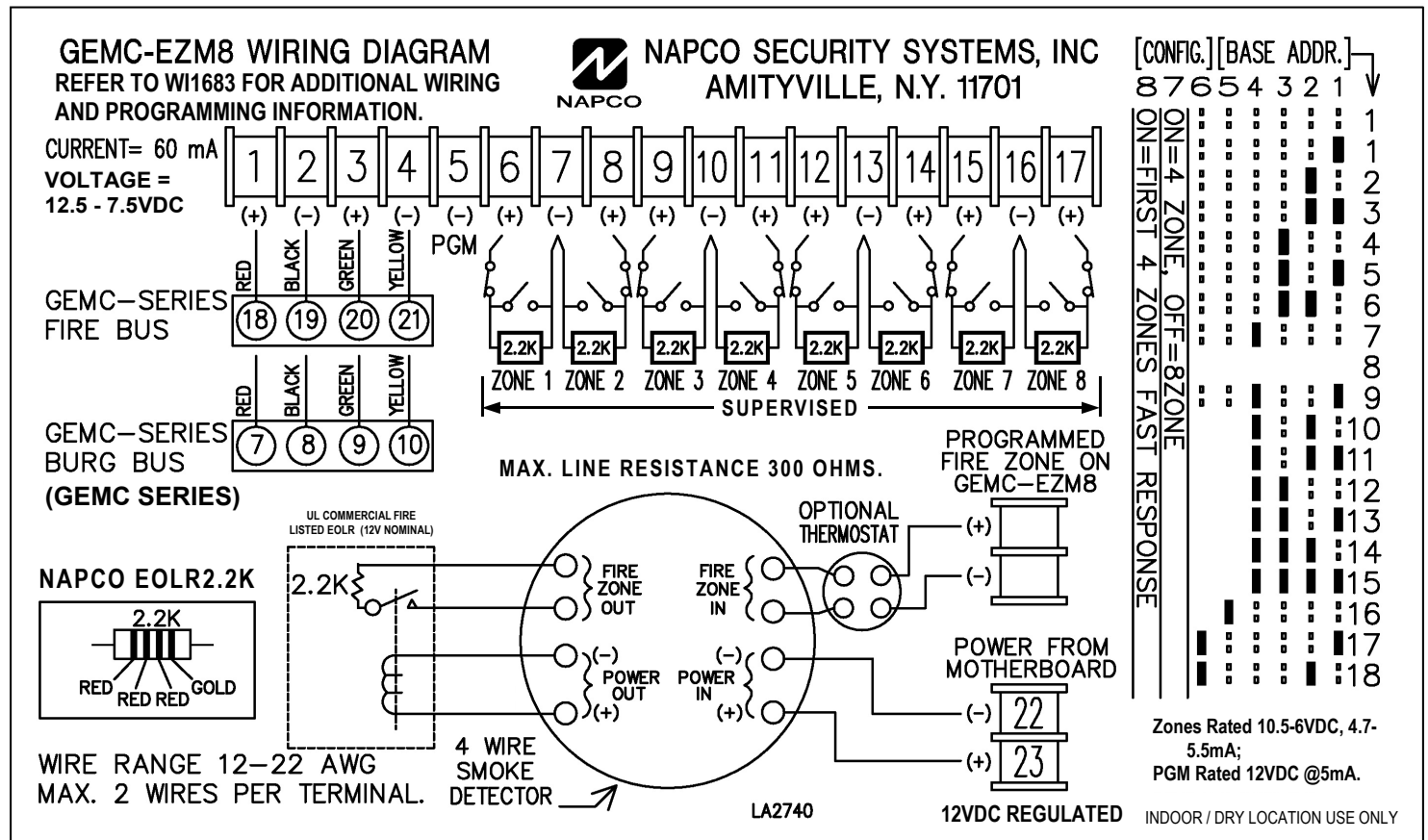

GEM-EZM8 Wiring Diagram

## 4 ZONE CONFIGURATION (1 EZM-4 ZONES)

Loop supervision with one contact using a 2.2K across the contact and a 2.2K EOL resistor, as shown in the illustration below:

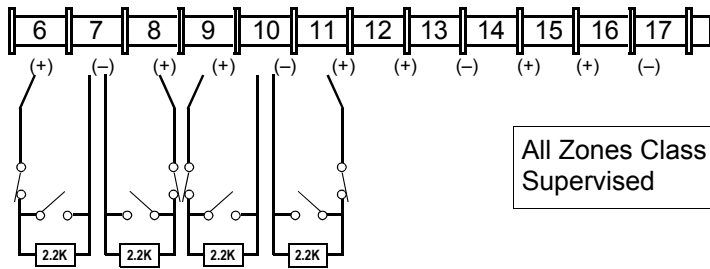

All Zones Class B, Style B and Supervised

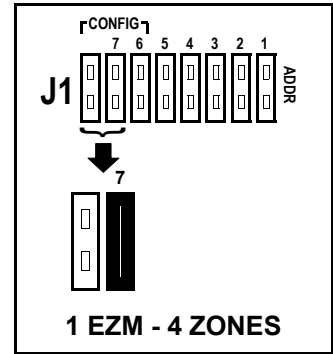

Types of devices include: Magnetic contacts PIR's, pull stations, heat detectors, waterflow tamper switches, 4-wire smokes, carbon monoxide detectors, etc.

## 8 ZONE CONFIGURATION (2 EZM-8 ZONES)

Loop supervision with one contact using a 2.2K across the contact and a 2.2K EOL resistor, as shown in the illustration below:

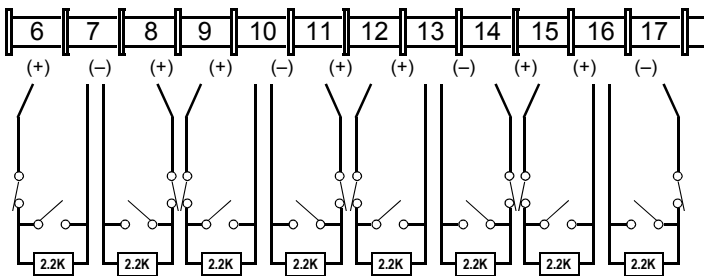

All Zones Class B, Style B and Supervised

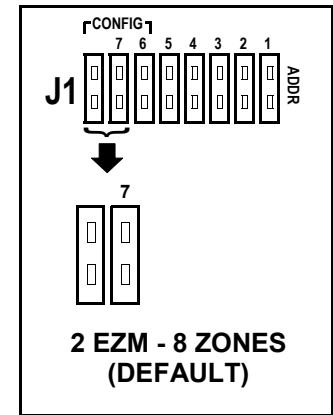

Types of devices include: Magnetic contacts PIR's, pull stations, heat detectors, waterflow tamper switches, 4-wire smokes, carbon monoxide detectors, etc.

### 4 OR 8 ZONE ASSIGNMENT

Regardless of how the modules are arranged, the expansion zones are divided into consecutively-numbered groups of four. Each module may comprise 1 group (4 zones) or 2 groups (8 zones). **NOTE:** The default setting is 2 groups (8 zones). Place jumper J1 on #7 for 4 zone, remove for 8 zone.

### BASE ADDRESS ASSIGNMENT

Every module must be assigned a unique "base address". The Base Address indicates which zones the module will contain. The base address depends on the number of zones used by the previous module or by the control panel. **NOTES:** (1) Groups must be numbered consecutively, that is, missing numbers are not permitted. (2) **NO TWO MODULES MAY BE NUMBERED ALIKE, EVEN IF THEY ARE ON SEPARATE BUSES.**

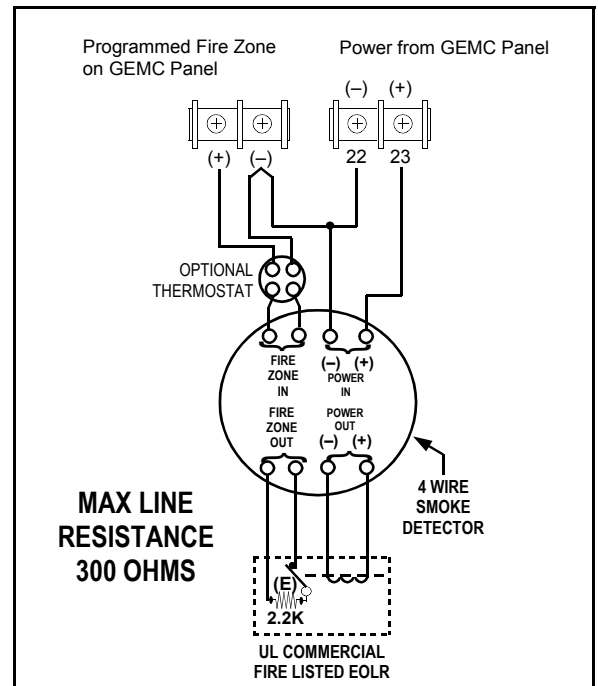

The base address is assigned to the module by proper selection of Address Jumpers (to the right of the LED) in accordance with the following tables. Also refer to the Zone Wiring Diagram.

Base Address	CONFIG		Base Address Jumpers						Without J7 installed		With J7 installed	
	First 4 Zone Loop Response	4 or 8 Zone EZM										
	8	7	6	5	4	3	2	1	First Zone #	Last Zone #	First Zone #	Last Zone #
1	OFF= 750mS ON = 50ms	OFF= 8Z ON = 4Z	OFF	OFF	OFF	OFF	OFF	OFF	9	16	9	12
1	OFF= 750mS ON = 50ms	OFF= 8Z ON = 4Z	OFF	OFF	OFF	OFF	OFF	ON	9	16	9	12
2	OFF= 750mS ON = 50ms	OFF= 8Z ON = 4Z	OFF	OFF	OFF	OFF	ON	OFF	13	20	13	16
3	OFF= 750mS ON = 50ms	OFF= 8Z ON = 4Z	OFF	OFF	OFF	OFF	ON	ON	17	24	17	20
4	OFF= 750mS ON = 50ms	OFF= 8Z ON = 4Z	OFF	OFF	OFF	ON	OFF	OFF	21	28	21	24
5	OFF= 750mS ON = 50ms	OFF= 8Z ON = 4Z	OFF	OFF	OFF	ON	OFF	ON	25	32	25	28
6	OFF= 750mS ON = 50ms	OFF= 8Z ON = 4Z	OFF	OFF	OFF	ON	ON	OFF	29	36	29	32
7	OFF= 750mS ON = 50ms	OFF= 8Z ON = 4Z	OFF	OFF	OFF	ON	ON	ON	33	40	33	36
8	OFF= 750mS ON = 50ms	OFF= 8Z ON = 4Z	OFF	OFF	ON	OFF	OFF	OFF	37	44	37	40
9	OFF= 750mS ON = 50ms	OFF= 8Z ON = 4Z	OFF	OFF	ON	OFF	OFF	ON	41	48	41	44
10	OFF= 750mS ON = 50ms	OFF= 8Z ON = 4Z	OFF	OFF	ON	OFF	ON	OFF	45	52	45	48

(Continued on next page)

## PROGRAMMING

The control panel must be programmed with regard to the total number of zones required. When keypad programming the control panel for the first time, the first programming option of the Easy Menu Driven Program Mode will be to enter the total number of zones in the system, rounded up to the nearest four. You can then support this total by adding the appropriate number of GEMC-EZM8 modules which can be configured as 4 or zone modules. The number of modules required is a function of the number of zones required as well as the configuration of the EZM's. If 24 additional zones are required (8 zones) is chosen, the number of EZM's required will be  $24/8 = 3$  EZM's.

When downloading a control panel, the total number of zones is determined on the Zone Features screen by activating the required number of EZM modules in the System Configuration screen.

## TAMPER

If the cover is removed or if the module is removed from the wall, the keypad sounder will pulse, and the display will indicate a zone-module tamper condition along with the module number. Press **RESET** to silence the sounder. **Note:** The EZM tamper displays differently depending on the bus to which it is wired. **Note:** The tamper will NOT function when used on a GEMC-Series control panel Fire system or Combination Fire/Burglary system (when the GEMC-EZM8 is programmed as a **4 Zone Fire** type or **8 Zone Fire** type in the Quickloader **System Assignment** screen).

## LOOP RESPONSE

Loop response times for Zones 1 through 8 are programmed in the control panel. Normal loop response for all expansion zones is 750mS. The module already comes without the jumper installed (defaulted to 750mS). To reduce the response time of zones 1 through 4 of the EZM Module to 50mS, add the Loop Response Jumper (jumper # 8 on = 50mS; off = 750mS). To enable normal loop response (750mS), remove the jumper. Refer to the Wiring Diagram. **DO NOT ENABLE THIS FEATURE IN UL INSTALLATIONS.**

## STATUS LED

The Status LED displays the condition of the zone module. The following is a list of conditions for the LED:

1. OFF = Control Panel has no power applied.
2. ON Steady = Control Panel has power applied but the panel is not polling because:
  - a. the panel is in "CONFIG",
  - b. the panel is not programmed correctly to poll the address of the EZM,
  - c. the GRN wire is not connected correctly.
3. PULSES off the EZM groups that are being polled.
  - a. If the first EZM group (the base number) is polled the LED is normally on and pulses off once slowly.
  - b. If the first and second EZM group are polled then the LED is normally on and pulses off once then twice sequentially.
  - c. If the first, second, third and fourth groups are polled the LED is normally off and will pulse 1, 2, 3, 4 sequentially.

Base Address	CONFIG		Base Address Jumpers						Without J7 installed		With J7 installed	
	First 4 Zone Loop Response	4 or 8 Zone EZM										
	8	7	6	5	4	3	2	1	First Zone #	Last Zone #	First Zone #	Last Zone #
11	OFF= 750mS ON = 50ms	OFF= 8Z ON = 4Z	OFF	OFF	ON	OFF	ON	ON	49	56	49	52
12	OFF= 750mS ON = 50ms	OFF= 8Z ON = 4Z	OFF	OFF	ON	ON	OFF	OFF	53	60	53	56
13	OFF= 750mS ON = 50ms	OFF= 8Z ON = 4Z	OFF	OFF	ON	ON	OFF	ON	57	64	57	60
14	OFF= 750mS ON = 50ms	OFF= 8Z ON = 4Z	OFF	OFF	ON	ON	ON	OFF	61	68	61	64
15	OFF= 750mS ON = 50ms	OFF= 8Z ON = 4Z	OFF	OFF	ON	ON	ON	ON	65	72	65	68
16	OFF= 750mS ON = 50ms	OFF= 8Z ON = 4Z	OFF	ON	OFF	OFF	OFF	OFF	69	76	69	72
17	OFF= 750mS ON = 50ms	OFF= 8Z ON = 4Z	OFF	ON	OFF	OFF	OFF	ON	73	80	73	76
18	OFF= 750mS ON = 50ms	OFF= 8Z ON = 4Z	OFF	ON	OFF	OFF	ON	OFF	77	84	77	80
19	OFF= 750mS ON = 50ms	OFF= 8Z ON = 4Z	OFF	ON	OFF	OFF	ON	ON	81	88	81	84
20	OFF= 750mS ON = 50ms	OFF= 8Z ON = 4Z	OFF	ON	OFF	ON	OFF	OFF	85	92	85	88
21	OFF= 750mS ON = 50ms	OFF= 8Z ON = 4Z	OFF	ON	OFF	ON	OFF	ON	89	96	89	92
22	OFF= 750mS ON = 50ms	OFF= 8Z ON = 4Z	OFF	ON	OFF	ON	ON	OFF	93	100	93	96
23	OFF= 750mS ON = 50ms	OFF= 8Z ON = 4Z	OFF	ON	OFF	ON	ON	ON	97	104	97	100
24	OFF= 750mS ON = 50ms	OFF= 8Z ON = 4Z	OFF	ON	ON	OFF	OFF	OFF	101	108	101	104
25	OFF= 750mS ON = 50ms	OFF= 8Z ON = 4Z	OFF	ON	ON	OFF	OFF	ON	105	112	105	108
26	OFF= 750mS ON = 50ms	OFF= 8Z ON = 4Z	OFF	ON	ON	OFF	ON	OFF	109	116	109	112
27	OFF= 750mS ON = 50ms	OFF= 8Z ON = 4Z	OFF	ON	ON	OFF	ON	ON	113	120	113	116
28	OFF= 750mS ON = 50ms	OFF= 8Z ON = 4Z	OFF	ON	ON	ON	OFF	OFF	117	124	117	120
29	OFF= 750mS ON = 50ms	OFF= 8Z ON = 4Z	OFF	ON	ON	ON	OFF	ON	121	128	121	124
30	OFF= 750mS ON = 50ms	OFF= 8Z ON = 4Z	OFF	ON	ON	ON	ON	OFF	125	132	125	128
31	OFF= 750mS ON = 50ms	OFF= 8Z ON = 4Z	OFF	ON	ON	ON	ON	ON	129	136	129	132
32	OFF= 750mS ON = 50ms	OFF= 8Z ON = 4Z	ON	OFF	OFF	OFF	OFF	OFF	133	140	133	136
33	OFF= 750mS ON = 50ms	OFF= 8Z ON = 4Z	ON	OFF	OFF	OFF	OFF	ON	137	144	137	140
34	OFF= 750mS ON = 50ms	OFF= 8Z ON = 4Z	ON	OFF	OFF	OFF	ON	OFF	141	148	141	144
35	OFF= 750mS ON = 50ms	OFF= 8Z ON = 4Z	ON	OFF	OFF	OFF	ON	ON	145	152	145	148
36	OFF= 750mS ON = 50ms	OFF= 8Z ON = 4Z	ON	OFF	OFF	ON	OFF	OFF	149	156	149	152
37	OFF= 750mS ON = 50ms	OFF= 8Z ON = 4Z	ON	OFF	OFF	ON	OFF	ON	153	160	153	156
38	OFF= 750mS ON = 50ms	OFF= 8Z ON = 4Z	ON	OFF	OFF	ON	ON	OFF	157	164	157	160
39	OFF= 750mS ON = 50ms	OFF= 8Z ON = 4Z	ON	OFF	OFF	ON	ON	ON	161	168	161	164
40	OFF= 750mS ON = 50ms	OFF= 8Z ON = 4Z	ON	OFF	ON	OFF	OFF	OFF	165	172	165	168

(Continued on next page)

Base Address	CONFIG		Base Address Jumpers						Without J7 installed		With J7 installed	
	First 4 Zone Loop Response	4 or 8 Zone EZM										
	8	7	6	5	4	3	2	1	First Zone #	Last Zone #	First Zone #	Last Zone #
41	OFF= 750mS ON = 50ms	OFF= 8Z ON = 4Z	ON	OFF	ON	OFF	OFF	ON	169	176	169	172
42	OFF= 750mS ON = 50ms	OFF= 8Z ON = 4Z	ON	OFF	ON	OFF	ON	OFF	173	180	173	176
43	OFF= 750mS ON = 50ms	OFF= 8Z ON = 4Z	ON	OFF	ON	OFF	ON	ON	177	184	177	180
44	OFF= 750mS ON = 50ms	OFF= 8Z ON = 4Z	ON	OFF	ON	ON	OFF	OFF	181	188	181	184
45	OFF= 750mS ON = 50ms	OFF= 8Z ON = 4Z	ON	OFF	ON	ON	OFF	ON	185	192	185	188
46	OFF= 750mS ON = 50ms	OFF= 8Z ON = 4Z	ON	OFF	ON	ON	ON	OFF	189	196	189	192
47	OFF= 750mS ON = 50ms	OFF= 8Z ON = 4Z	ON	OFF	ON	ON	ON	ON	193	200	193	196
48	OFF= 750mS ON = 50ms	OFF= 8Z ON = 4Z	ON	ON	OFF	OFF	OFF	OFF	197	204	197	200
49	OFF= 750mS ON = 50ms	OFF= 8Z ON = 4Z	ON	ON	OFF	OFF	OFF	ON	201	208	201	204
50	OFF= 750mS ON = 50ms	OFF= 8Z ON = 4Z	ON	ON	OFF	OFF	ON	OFF	205	212	205	208
51	OFF= 750mS ON = 50ms	OFF= 8Z ON = 4Z	ON	ON	OFF	OFF	ON	ON	209	216	209	212
52	OFF= 750mS ON = 50ms	OFF= 8Z ON = 4Z	ON	ON	OFF	ON	OFF	OFF	213	220	213	216
53	OFF= 750mS ON = 50ms	OFF= 8Z ON = 4Z	ON	ON	OFF	ON	OFF	ON	217	224	217	220
54	OFF= 750mS ON = 50ms	OFF= 8Z ON = 4Z	ON	ON	OFF	ON	ON	OFF	221	228	221	224
55	OFF= 750mS ON = 50ms	OFF= 8Z ON = 4Z	ON	ON	OFF	ON	ON	ON	225	232	225	228
56	OFF= 750mS ON = 50ms	OFF= 8Z ON = 4Z	ON	ON	ON	OFF	OFF	OFF	229	236	229	232
57	OFF= 750mS ON = 50ms	OFF= 8Z ON = 4Z	ON	ON	ON	OFF	OFF	ON	233	240	233	236
58	OFF= 750mS ON = 50ms	OFF= 8Z ON = 4Z	ON	ON	ON	OFF	ON	OFF	237	244	237	240
59	OFF= 750mS ON = 50ms	OFF= 8Z ON = 4Z	ON	ON	ON	OFF	ON	ON	241	248	241	244
60	OFF= 750mS ON = 50ms	OFF= 8Z ON = 4Z	ON	ON	ON	ON	OFF	OFF	245	252	245	248
61	OFF= 750mS ON = 50ms	OFF= 8Z ON = 4Z	ON	ON	ON	ON	OFF	ON	249	256	249	252
62	OFF= 750mS ON = 50ms	OFF= 8Z ON = 4Z	ON	ON	ON	ON	ON	OFF	253	260	253	256
63	OFF= 750mS ON = 50ms	OFF= 8Z ON = 4Z	ON	ON	ON	ON	ON	ON	X	X	X	X

# NOTES

# NOTES

# NAPCO LIMITED WARRANTY

NAPCO SECURITY SYSTEMS, INC. (NAPCO) warrants its products to be free from manufacturing defects in materials and workmanship for *thirty-six months* following the date of manufacture. NAPCO will, within said period, at its option, repair or replace any product failing to operate correctly without charge to the original purchaser or user.

This warranty shall not apply to any equipment, or any part thereof, which has been repaired by others, improperly installed, improperly used, abused, altered, damaged, subjected to acts of God, or on which any serial numbers have been altered, defaced or removed. Seller will not be responsible for any dismantling or reinstallation charges.

THERE ARE NO WARRANTIES, EXPRESS OR IMPLIED, WHICH EXTEND BEYOND THE DESCRIPTION ON THE FACE HEREOF. THERE IS NO EXPRESS OR IMPLIED WARRANTY OF MERCHANTABILITY OR A WARRANTY OF FITNESS FOR A PARTICULAR PURPOSE. ADDITIONALLY, THIS WARRANTY IS IN LIEU OF ALL OTHER OBLIGATIONS OR LIABILITIES ON THE PART OF NAPCO.

Any action for breach of warranty, including but not limited to any implied warranty of merchantability, must be brought within the six months following the end of the warranty period. IN NO CASE SHALL NAPCO BE LIABLE TO ANYONE FOR ANY CONSEQUENTIAL OR INCIDENTAL DAMAGES FOR BREACH OF THIS OR ANY OTHER WARRANTY, EXPRESS OR IMPLIED, EVEN IF THE LOSS OR DAMAGE IS CAUSED BY THE SELLER'S OWN NEGLIGENCE OR FAULT.

In case of defect, contact the security professional who installed and maintains your security system. In order to exercise the warranty, the product must be returned by the security professional, shipping costs prepaid and insured to NAPCO. After repair or replacement, NAPCO assumes the cost of returning products under warranty. NAPCO shall have no obligation under this warranty, or otherwise, if the product has been repaired by others, improperly installed, improperly used, abused, altered, damaged, subjected to accident, nuisance, flood, fire or acts of God, or on which any serial numbers have been altered, defaced or removed. NAPCO will not be responsible for any dismantling, reassembly or reinstallation charges.

This warranty contains the entire warranty. It is the sole warranty and any prior agreements or representations, whether oral or written, are either merged herein or are expressly cancelled. NAPCO neither assumes, nor authorizes any other person purporting to act on its

behalf to modify, to change, or to assume for it, any other warranty or liability concerning its products.

In no event shall NAPCO be liable for an amount in excess of NAPCO's original selling price of the product, for any loss or damage, whether direct, indirect, incidental, consequential, or otherwise arising out of any failure of the product. Seller's warranty, as hereinabove set forth, shall not be enlarged, diminished or affected by and no obligation or liability shall arise or grow out of Seller's rendering of technical advice or service in connection with Buyer's order of the goods furnished hereunder.

NAPCO RECOMMENDS THAT THE ENTIRE SYSTEM BE COMPLETELY TESTED WEEKLY.

**Warning:** Despite frequent testing, and due to, but not limited to, any or all of the following; criminal tampering, electrical or communications disruption, it is possible for the system to fail to perform as expected. NAPCO does not represent that the product/system may not be compromised or circumvented; or that the product or system will prevent any personal injury or property loss by burglary, robbery, fire or otherwise; nor that the product or system will in all cases provide adequate warning or protection. A properly installed and maintained alarm may only reduce risk of burglary, robbery, fire or otherwise but it is not insurance or a guarantee that these events will not occur. CONSEQUENTLY, SELLER SHALL HAVE NO LIABILITY FOR ANY PERSONAL INJURY, PROPERTY DAMAGE, OR OTHER LOSS BASED ON A CLAIM THE PRODUCT FAILED TO GIVE WARNING. Therefore, the installer should in turn advise the consumer to take any and all precautions for his or her safety including, but not limited to, fleeing the premises and calling police or fire department, in order to mitigate the possibilities of harm and/or damage.

NAPCO is not an insurer of either the property or safety of the user's family or employees, and limits its liability for any loss or damage including incidental or consequential damages to NAPCO's original selling price of the product regardless of the cause of such loss or damage.

Some states do not allow limitations on how long an implied warranty lasts or do not allow the exclusion or limitation of incidental or consequential damages, or differentiate in their treatment of limitations of liability for ordinary or gross negligence, so the above limitations or exclusions may not apply to you. This Warranty gives you specific legal rights and you may also have other rights which vary from state to state.

## IMPORTANT WIRING METHODS

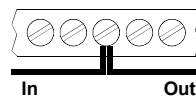
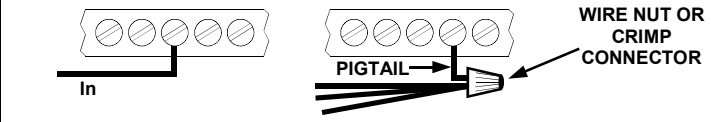
 <p><b>For single-conductor terminal blocks</b> (like the type shown at left), to terminate more than one conductor to a terminal, use the wiring methods shown at right:</p>	 <p>Incorrect</p>	 <p>Correct -- Single incoming and/or pigtail with wire nut / crimp connectors</p>
---	--	--

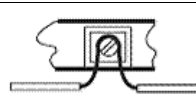
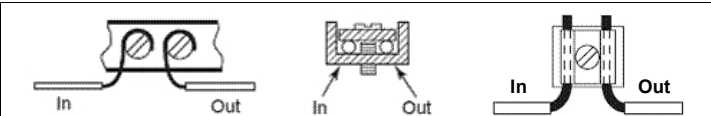
 <p><b>For "barrier" type terminal blocks</b> (like the type shown at left), to terminate two conductors to a terminal, use the wiring methods shown at right:</p>	 <p>Incorrect</p>	 <p>Correct -- Separate incoming and outgoing conductors</p>
--	--	--

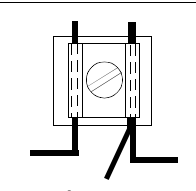
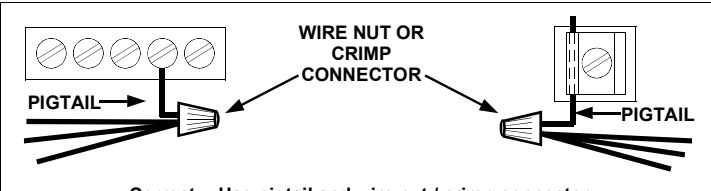
<p><b>To terminate more than two conductors</b> or conductors of different wire sizes to a terminal, use the "pigtail" type wiring method as shown at right. Use insulated wire for the pigtail, and firmly secure the conductors to the pigtail using an appropriate wire nut or crimp connector for the number and gauge of conductors used.</p>	 <p>Incorrect</p>	 <p>Correct -- Use pigtail and wire nut / crimp connector</p>
--	--	---